

CONTENIDO PARTES Y PIEZAS

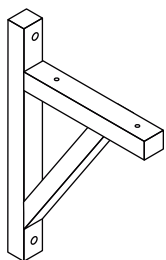

1 x2 (escuadra)

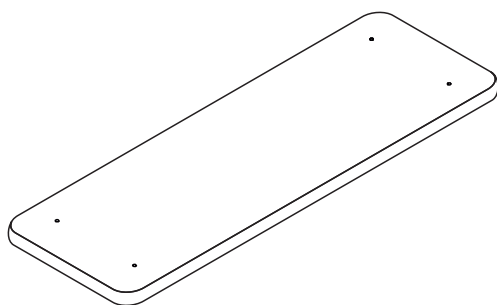

2 x1 (cubierta)

HERRAJES

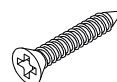

A x4 (tornillo)

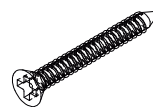

B x4 (tornillo)

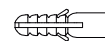

C x4 (tarugo)

INSTRUCCIONES DE ARMADO

Paso 1: Fija las escuadras 1 a la cubierta 2 usando los tornillos A y ayudándote con un destornillador.

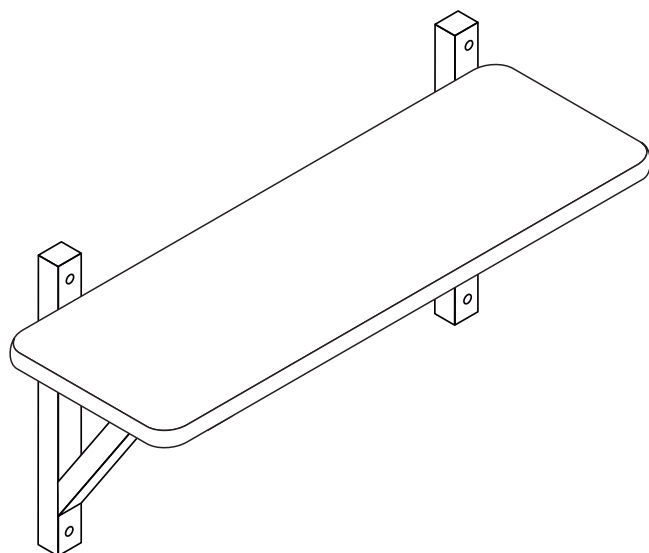
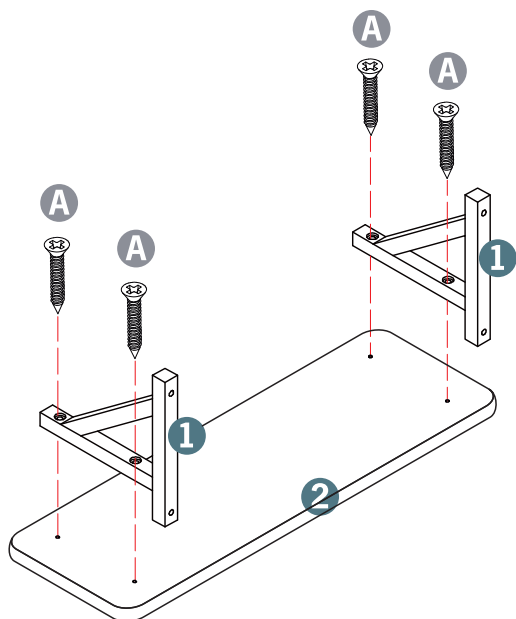

Paso 2: Usando los tarugos C y los tornillos B fije la estructura al muro ayudándote con un destornillador.

